















Specifications

Model	GTH™-4016 R	
Measurements	Metric	Imperial
Lifting height maximum with outriggers	15.42 m	50 ft 7 in
Lifting height maximum without outriggers	15.31 m	50 ft 3 in
Lifting capacity maximum	4,000 kg	8,818 lbs
Lift capacity at maximum height	2,500 kg	5,511 lbs
Lift capacity at maximum reach	700 kg	1,543 lbs
Forward reach maximum	13.35 m	43 ft 10 in
Reach at maximum height	3.42 m	11 ft 4 in
 Height	2.99 m	9 ft 9 in
 Height at steering wheel	2.22 m	7 ft 3 in
 Width	2.42 m	7 ft 11 in
 Cab width	0.93 m	3 ft
 Track	1.95 m	6 ft 5 in
 Wheelbase	3.00 m	9 ft 10 in
 Length at front wheels	4.66 m	15 ft 3 in
 Length at fork-holder plate	6.76 m	22 ft 2 in
 Ground clearance	0.36 m	1 ft 2 in
 Overall width, outriggers extended	3.64 m	11 ft 11 in
 Side rear overhang	2.60 m	8 ft 6 in
 Side front overhang	4.16 m	13 ft 8 in
 Overall length	7.96 m	26 ft 1 in
 Obstruction angle		31°
 Departure angle		31°

Productivity

Inside/outside turning radius	2.37 m/4.22 m	7 ft 9 in/13 ft 10 in
Break-out force*	5,900 kg	13,007 lbs
Towing capacity at dynamometer**	8,086 kg	17,826 lbs
Drive speed max.	30 km/h	19 mph
Fork-holder plate rotation		138°
Tyres (DIN 70361)	18-19.5" PR16 10 holes wheel disc	
Lifting/lowering speed**	14 sec./9 sec.	
Extension/retraction speed**	35 sec./19 sec.	

Power

Engine	Perkins 854E-E34TA turbo diesel 83 kW (111 hp), stage IIIB Perkins 1104D-E44T turbo diesel 75 kW (100 hp), stage IIIA	
Transmission	Hydrostatic variable displacement pump linked to variable displacement motor. 2-speed mechanical gearbox.	
Service pumps	Boom & control system gear pump type: 280 Bar, 94 L/min.	
Petrol tank capacities	205 L	54 gal
Engine oil capacities	8.3 L	2.12 gal
Hydraulic oil tank capacities	220 L	58 gal

Weight*** 13,775 kg 30,368 lbs

Standards Compliance

EU Machinery Directive 2006/42/EC
 Operating cab conforms to ISO3471 (ROPS) and ISO3449 (FOPS)
 Low emission engine conforms to EU Directive 97/68/EC Stage III and 2004/26/EC
 Noise emission conforms to EU Directive 2000/14/EC (LpA=74 dB, LwA=103dB)
 Vibration levels according to EN13059:2002 (hand-arm <2.5m/s², whole body 0.35m/s²)

Measurements

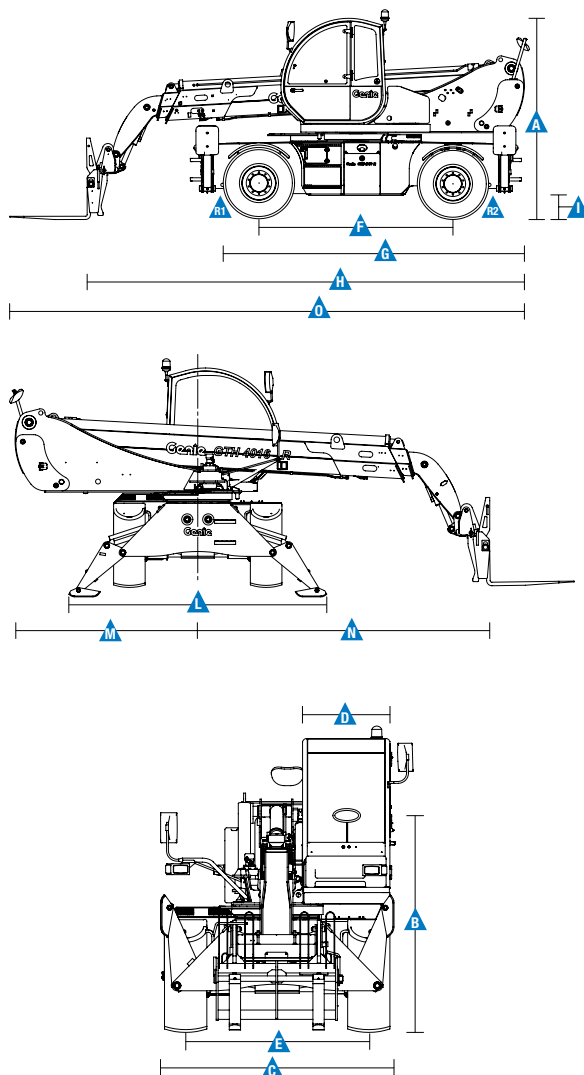

* With 800 L shovel SAE J 732/80

** Without load

*** Weight will vary depending on options and/or country standards

Load Charts

On wheels with forks

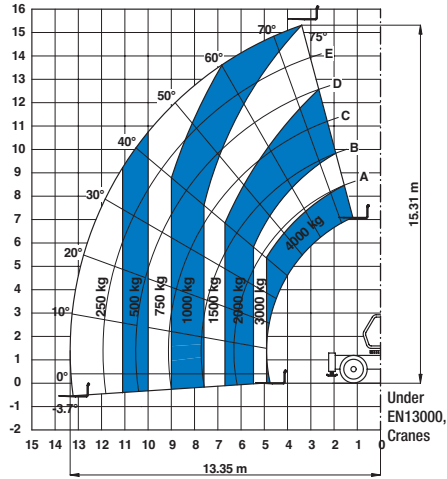

On outriggers with forks

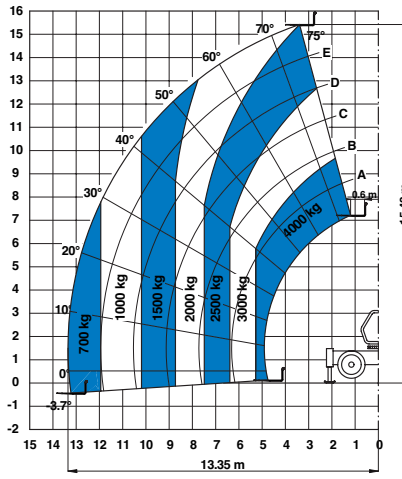

On wheels with 800 L shovel

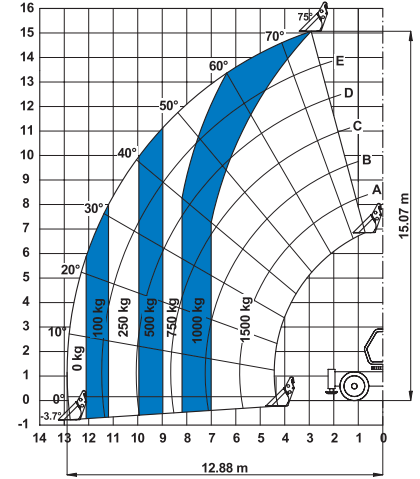

On outriggers with 5t fixed hook on plate

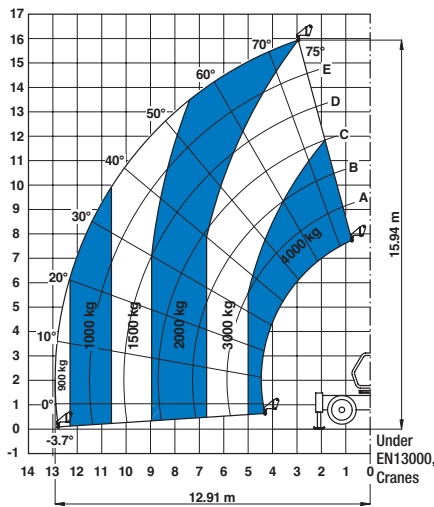

On outriggers with 2m jib (mechanical)

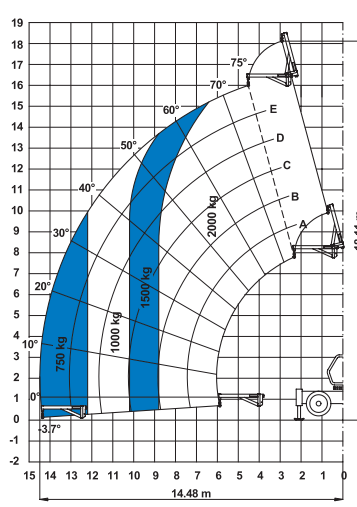

On outriggers with 4m jib (mechanical/hydraulic)

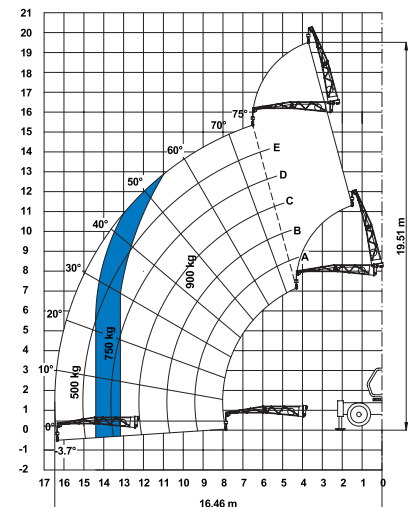

On outriggers with 4t hydraulic hoist

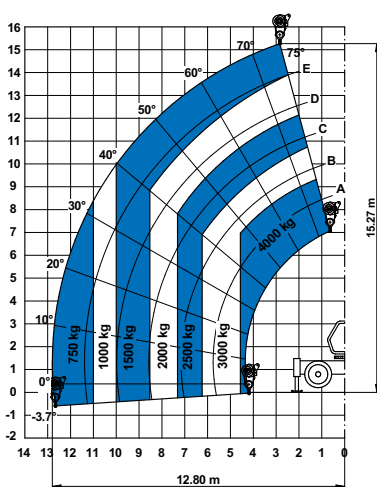

On outriggers with fixed work platform

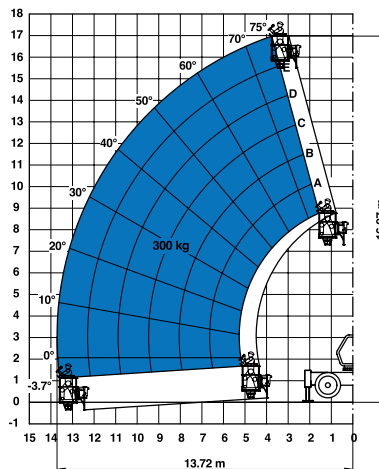

On outriggers with rotating extendable work platform

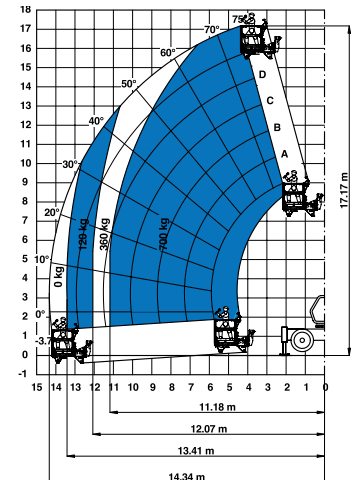



Attachment Options

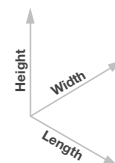



Dimension References







Fork attachments

	Part Number	Description	Payload	Width	Length	Height	Weight
	55.0750.0118	Floating forks	4,000 kg	1,380 mm	1,615 mm	1,260 mm	395 kg
	55.0750.0119	FEM 3 plate and forks kit	4,000 kg	1,390 mm	1,620 mm	1,175 mm	410 kg
	59.0601.5025	Hydraulic FEM 3 forks side-shift +/- 100 mm	4,000 kg	1,370 mm	1,700 mm	1,180 mm	545 kg



Bucket and shovel attachments

	Part Number	Description	Width	Length	Height	Weight	Hyd. flow max.
	59.0201.9022	800 L loading shovel	2,435 mm	1,170 mm	1,140 mm	510 kg	
	59.0401.2028	500 L concrete bucket manual discharge	1,110 mm	1,110 mm	1,320 mm	230 kg	
	59.0401.2029	500 L concrete bucket hydraulic discharge	1,110 mm	1,110 mm	1,320 mm	244 kg	60/220 lt/min/bar
	59.0401.2030	800 L concrete bucket manual discharge	1,110 mm	1,110 mm	1,520 mm	250 kg	
	59.0401.2031	800 L concrete bucket hydraulic discharge	1,110 mm	1,110 mm	1,520 mm	264 kg	60/220 L/min/bars
	59.0401.2016	500 L concrete mixing bucket full hydraulic	990 mm	1,650 mm	880 mm	550 kg	60/220 L/min/bars
	59.0401.2032	Brick holder basket	800 mm	1,110 mm	1,150 mm	120 kg	

Handling and lifting attachments

	Part Number	Description	Payload	Width	Length	Height*	Weight
	59.0700.9013	5T fixed hook on plate	3,000 kg	1,335 mm	830 mm	1,070/1,110 mm	160 kg
	59.0802.3027	2m/2000 kg mechanical jib	2,000 kg	1,335 mm	2,290 mm	800/1,080 mm	255 kg
	59.0802.3028	4m/900 Kg mechanical jib	900 kg	1,190 mm	4,450 mm	980/1,220 mm	245 kg
	59.0802.3029	4m/900 kg hydraulic jib	900 kg	1,190 mm	4,485 mm	1,220/1,610 mm	320 kg
	59.0901.9015	4T hydraulic hoist	4,000 kg	1,335 mm	830 mm	1,840/1,260 mm	380 kg

Work platform attachments

	Part Number	Description	Payload	Width**	Length	Height	Weight
	59.1111.6014	Rotating and extendable +/-90° 3 persons max.	700 kg	2,520 mm up to 4,610 mm	2,110 mm	1,850 mm	920 kg
	59.1111.6013	Fixed non extendable 2 persons max.	300 kg	2,300 mm	1,490 mm	1,710 mm	400 kg

* Legs folded up/down
** Stowed/extended

Features

Standard Features

Measurements

- 4,000 kg (8,818 lb) maximum lift capacity
- 15.42 m (50 ft 7 in) maximum lift height
- 13.35 m (43 ft 10 in) maximum forward reach

Productivity

- 4 x 4
- 4 - wheel steer
- 3 steering modes:
 - front wheel steer
 - crab steer
 - coordinated steer
- Hydraulic line on boom
- Electrical line on boom
- Power assisted steering
- Front and rear outriggers
- 400° rotation (200° left, 200° right)
- Hydrostatic transmission with variable displacement pump and motor linked with 2-speed mechanical gearbox
- Multifunction electro-proportional 5x1 joystick
- Limited slip differential on front axle
- Attachment holder plate – mechanical coupling
- Two-section door (glass upper/steel lower)
- Angle and length indicators on boom correspond to load charts
- Adjustable suspended seat with operator detection seat contact switch
- Battery disconnection switch
- Adjustable steering wheel
- Front & rear windscreen wipers
- Sunshield

Standard Features

- Roof protection grid
- Two side view mirrors & rear fish eye mirror
- Front & rear lights
- Side mounted engine for easy access to components
- Oil immersed, multi-disc brakes on both axles
- Lockable fuel tank
- Lockable storage box
- Maintenance collar
- Rear wheels alignment system
- Road/jobsite/work-platform switch
- Stability and load control system:
 - Load moment indicator with LEDs
 - Audible alarm
 - Automatic lock-out of boom extension and lowering
 - Automatic lock-out of stabilisers
 - Automatic lock-out of rear axle

Power

- Perkins turbo charged, air cooler diesel engine 83 kW (111 hp), stage IIIB
- Perkins turbo charged diesel engine 74 kW (98 hp), stage IIIA

Tyres

- 18-19.5" PR16. 10 holes wheel disc

Options & Accessories

Productivity

- 360° Continuous rotation
- Chassis leveling +/- 7°
- Air conditioning
- Additional hydraulic line on boom
- Hydraulic quick coupling for attachments
- Adjustable spotlight on boom
- Adjustable spotlight on cab
- Windshield protection grid
- Wiper on cab roof
- Trailer coupling
- Outriggers extension plates
- Biodegradable hydraulic oil
- 10 t hydraulic jack + 24 mm box wrench
- Left-hand joystick
- Radio remote control
- Concrete mixing bucket pre-arrangement
- Work platform attachment pre-arrangement
- Comfortable seat/ergonomic armrest
- Radio MP3
- Keypad unlocking device
- Track and trace
- 12 V charger
- Visible and audible crane warning light on cabin roof

Tyres and Wheels

- Spare wheel 18R19.5 TL XF
- Foam filled tyre 18R19.5
- Foam filled spare wheel 18R19.5

Attachments

- Floating forks L 1200 mm, section 120x50 mm
- FEM 3 plate and forks kit
- FEM 3 forks with hydraulic side-shift (+/-100 mm)
- 800 L loading shovel
- 500/800 L concrete bucket (manual or hydraulic discharge)
- 500 L concrete mixing bucket (full hydraulic)
- Brick-holder basket
- Fixed hook on plate
- 2 m mechanical extension jib, 2,000 kg capacity
- 4 m mechanical or hydraulic extension jib, 900 kg capacity
- 4 t hydraulic winch
- Fixed work platform
- Rotating and extendable work platform



03/16. Part No. B108033UK

United Kingdom

The Maltings, Wharf Road, Grantham NG31 6BH, T: +44 800 988 3739 (toll free), Fax +44 (0)1476 584334, Email AWP-InfoEurope@terex.com
Visit www.genielift.co.uk/locations to view our global locations list.

Worldwide Manufacturing And Distribution

Australia · Brazil · Caribbean · Central America · China · France · Germany · Italy · Japan · Korea · Mexico · Russia · Southeast Asia · Spain · Sweden · United Arab Emirates · United Kingdom · United States

Product specifications and prices are subject to change without notice or obligation. The photographs and/or drawings in this document are for illustrative purposes only. Refer to the appropriate Operator's Manual for instructions on the proper use of this equipment. Failure to follow the appropriate Operator's Manual when using our equipment or to otherwise act irresponsibly may result in serious injury or death. The only warranty applicable to our equipment is the standard written warranty applicable to the particular product and sale and we make no other warranty, express or implied. Products and services listed may be trademarks, service marks or trade names of Terex Corporation and/or their subsidiaries in the USA and many other countries. Genie is a registered trademark of Terex South Dakota, Inc. © 2016 Terex Corporation.

